



Pump Model - version

EUROINOX 50-50 M - N.4.- -

Attention: check the correspondence with the serial number of the pump.

Company Name
Contact
Telephone
FAX
E-Mail address

Receiver

From

EUROINOX 50-50 M - N.4.- - @ 102970300_c

EUROINOX 50-50 M @ 102970300

Item	Quant	Item no.	Description	Unit pr.
1	1	148121110	SP.P. PUMP BODY	On req.
10	1	130645720	&SP.P.MOTOR MEC71 H90 01 220/240/50	On req.
11	1	164030020	MEC 71 MOTOR COVER	On req.
12	1	160760240	FAN MEC71	On req.
127	1	161560190	MOTOR FOOT MEC71	On req.
13	1	147120540	KIT FAN COVER W/SCREW MEC71/01	On req.
14	1	164060410	TERMINAL BOX COVER	On req.
15	1	002210558	V-RING D.13,5-15X5,5H	On req.
16	1	148620490	COMPLETE MECH.SEALD.15	On req.
18	1	002520633	HEX.NUT AUTOB.M8 INOX A4 UNI7474	On req.
19	1	002310103	6302-2RSH D.15X42X13 BEARING	On req.
20	1	002310102	6202-2RSH D.15X35X11 BEARING	On req.
21	1	002570001	LMKAS D.35B THRUST WASHER	On req.
23	1	002710018	25 UF X 450V CAPACITOR MAX D.45X 71MM	On req.
24	3	167100660	M5 X 160 MOTOR TIE ROD	On req.
25	1	147120340	PRIMING PLUG 3/8"GAS +O-RING	On req.
26	1	147120340	PRIMING PLUG 3/8"GAS +O-RING	On req.
28	1	002220377	OR-4600 151,99X 3,53 NBR	On req.
3	1	161430090	MOTOR SUPPORT MEC 71	On req.
30	1	168300150	SEAL WASHER A.316	On req.
304	1	161060560	REAR DISC	On req.
305	1	142860070	SP.P. FLANGE	On req.
319	1	146860000	PREMON.MORSET-FERMAC.	On req.
324	1	168560331	CAPACITOR LOCKER MEC63-71	On req.
328	1	168300240	PUMP BODY WASHER	On req.
36	1	161000290	DISC SEAL.A.304	On req.
4	5	150761091	IMPELLER A316 GFN2	On req.
43	1	002523059	WASHER 8,4X17AISI316UNI6592	On req.

NON INTERACTIVE

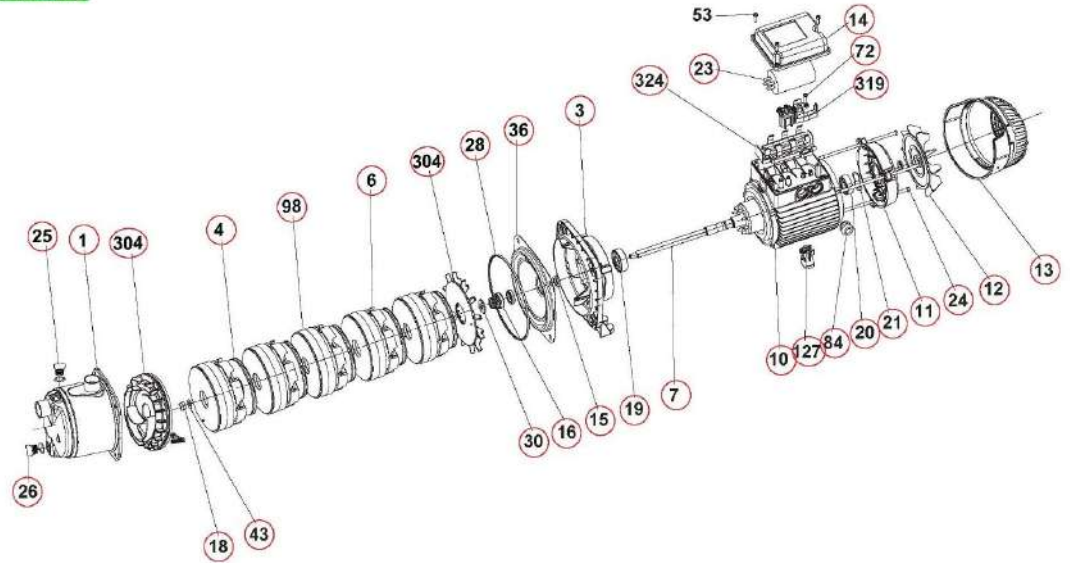

Project	Project ID	Created by	Created on 2011-01-07	Last update
---------	------------	------------	--------------------------	-------------



Pump Model - version

EUROINOX 50-50 M - N.4.- -

Attention: check the correspondence with the serial number of the pump.

Company Name
Contact
Telephone
FAX
E-Mail address

Receiver

From

Serial Number

EUROINOX 50-50 M - N.4.- - @ 102970300_c

EUROINOX 50-50 M @ 102970300

Item	Quant	Item no.	Description	Unit pr.
6	5	162860480	DIFFUSOR NORYL	On req.
7	1	145003010	SP. P. SHAFT W/ROT.	On req.
84	1	168560310	OPEN CABLE GLAND	On req.
98	5	161360480	DIFFUSER BODY -NORYL	On req.

NON INTERACTIVE

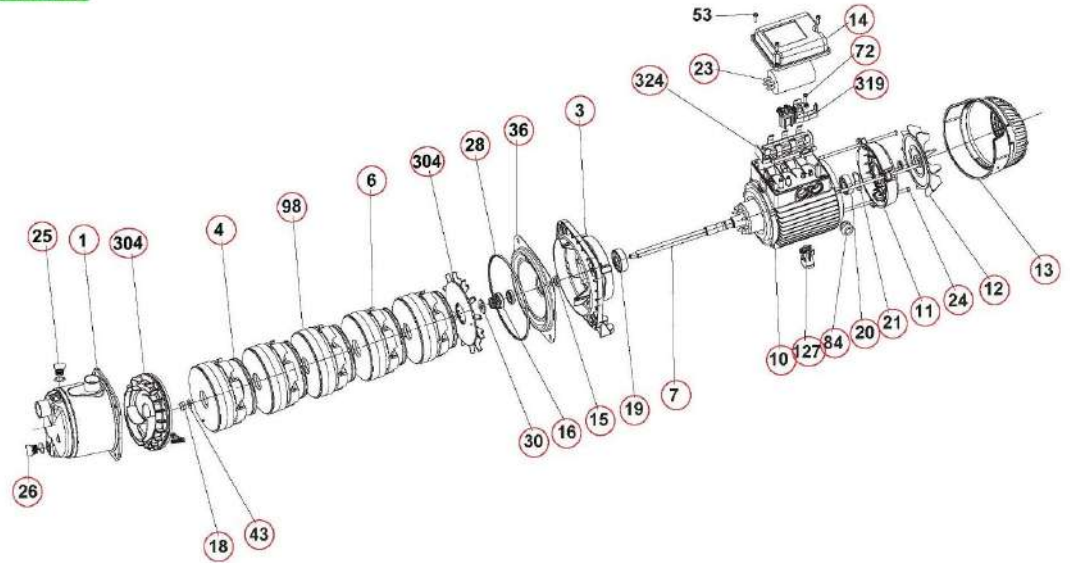

Project

Project ID

Created by

Created on
2011-01-07

Last update